

WILDVIEW INFRARED XTREME



INSTRUCTION MANUAL

For Models: TGL51RNXTS1

For French language manual: Please visit our website to download a PDF version.
Pour consulter le manuel en français: S'il vous plaît visitez notre site Web pour télécharger une PDF version.

Toll Free 1-888-304-6125

www.wildviewcam.com

Version 1.0

12/10

**** IMPORTANT NOTE ****

First, congratulations on purchasing one of the finest scouting cameras on the market today. We appreciate your business and want to prove to you we are committed to providing you the best product and support in the field.

By giving our customers a new state of the art web interface, which provides you with video tutorials and instruction on how to use the product in the most effective way.

TECHNICAL SUPPORT

EMAIL: wildview@gsmorg.com

Please allow 48hrs for response.

WILDVIEW

P.O. Box 535189

Grand Prairie, TX 75053-9504

CUSTOMER SERVICE

CONTACT & HOURS

Toll Free: 1-888-304-6125

Call Center Hours:

Mon - Fri / 8 AM – 6 PM (CST)

www.wildviewcam.com

Wildview Limited Warranty

Your Wildview scouting camera is covered by a One Year Limited Warranty on parts and labor from the date of original purchase, and purchases must be made through an authorized dealer. The warranty covers defects in workmanship and materials. The warranty does not apply to units, which have been damaged or abused intentionally or unintentionally. A purchase from individuals or unauthorized internet sites such as eBay voids the warranty.

Tampering with or altering the unit will void the warranty. Any unauthorized service will void warranty. A copy of your original sales receipt must be produced for any warranty service and a Return Authorization (RA) number must be obtained from customer service at 888-304-6125 prior to returning product.

www.wildviewcam.com

Toll Free 888-304-6125

TABLE OF CONTENTS

Camera Overview	4
Camera Kit contents	7
General Information	8
Battery and Memory Installation	9
Setup and Programming	12
Using the camera	16
Viewing and Deleting files	20
Memory Compatibility chart	24
Technical Specs	25
Camera Features and Specs	26
Image Capacity Chart	27
Moon Phase Chart	28
Frequently Asked Questions (FAQs)	29
FCC Compliance	31

CAMERA OVERVIEW

Front view

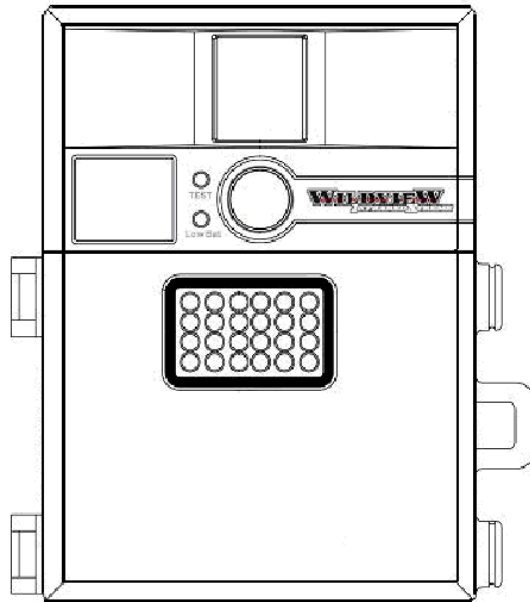

Side view

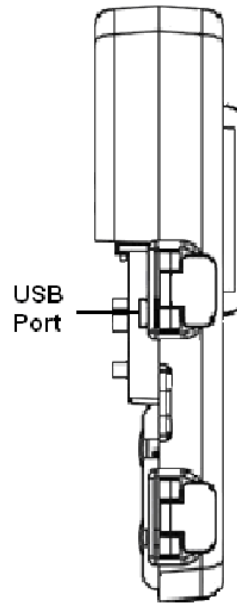

Open view image with major parts indication

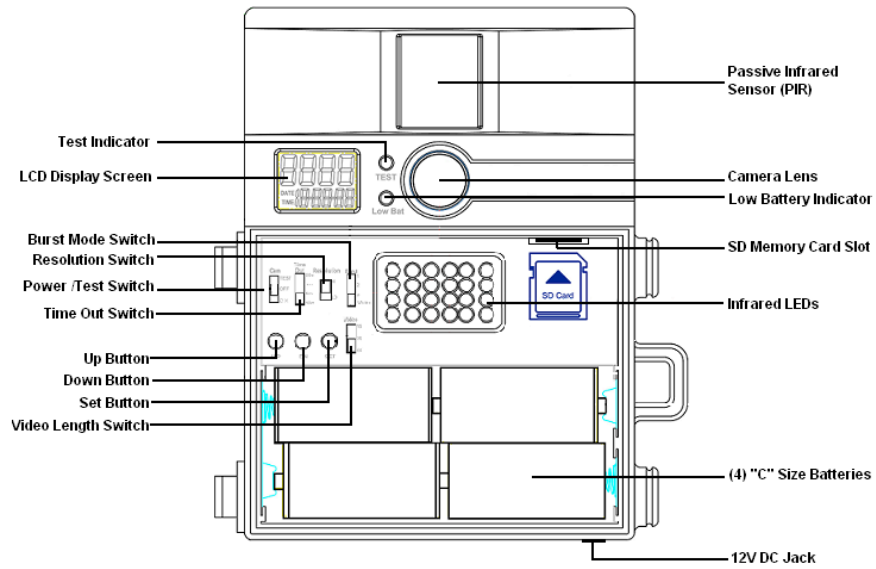

CAMERA KIT CONTENT

- Model TGL5IRNXTS1 Digital Scouting Camera
- User manual
- Strap

GENERAL INFORMATION

Special Care Instructions

- Operating Environment: 14 to 104 deg F (-10 to 40 deg C). 20-85% relative humidity, non-condensing.
- The camera is designed to be weather resistant. Never attempt to immerse the unit in water or any other liquid. This will damage the unit and void the warranty.
- Use a soft lens cloth for cleaning lens. Avoid touching lens with fingers.
- Remove dirt or stains with a soft cloth dampened with water or neutral detergent. Keep your camera in a dry and cool dust-free environment or container when it is NOT used.
- Take the batteries out, when camera is NOT to be used over an extended period of time.
- Avoid dropping your camera on to a hard surface.
- Do not disassemble your camera.
- Do not mix new and old batteries.
- Do not open the camera for unauthorized service. This could cause serious damage to the unit and WILL void the warranty.
- When camera is turned off, if there is any residual power left in the camera, it will take an extra picture to discharge the remaining power in the camera. Under low lighting conditions, the flash will go off.

NOTE: This camera is a precision electronic device. Do not attempt to service this camera yourself, as opening or removing covers may expose you to dangerous voltage points or other risks.

BATTERY AND MEMORY INSTALLATION

WARNING: Do not use different Voltage lead acid battery other than the one specified in this section. Doing so will damage the camera and will void the warranty.

WARNING: ALWAYS have the camera in the *OFF* position when installing or removing batteries and memory card. Removing batteries or memory card while the camera is *ON* it may damage the camera.

Your Wildview Digital Scouting Camera is designed to operate using two different types of battery power options.

Batteries “C” cell

The internal battery compartment accepts 4 “C” cell batteries. Be sure to use high quality brand name alkaline batteries. Install batteries with correct polarity (+/-) as noted inside the battery compartment.

12V Lead Acid External Battery

The camera is equipped with an external power jack designed to accept a barrel plug cable that attaches to a sealed lead acid battery. (Sold separately). This will enhance the camera’s field life. Battery cable and complete 12V Lead Acid battery kits are available wherever Wildview scouting cameras are sold, or call toll free 888-304-6125. Only Wildview external battery accessories are recommended.

1. Make sure camera is in the *OFF* position.
2. Insert the external battery barrel plug into the DC 12V jack on the bottom of camera housing.

www.wildviewcam.com

Toll Free 888-304-6125

3. Turn the camera to the ON position.
4. The camera will automatically switch to external power when it is connected, even if the internal batteries are installed.

NOTE: Please make sure the voltage and polarity (+/-) are correct before connection. Incorrect voltage or polarity (+/-) will damage the camera. When both internal and external batteries are connected, the camera will draw power from the higher voltage source first.

Memory Options

The camera is also equipped with an expandable media card slot capable of accepting up to 16GB* SD card (sold separately). With no memory card inserted into the slot, the camera will use the built in SDRAM memory to store images. If an SD card is inserted into the slot, then the camera will bypass the built in memory and utilize the SD memory. The front counter display will show the number of images in the built in memory, unless the expansion card is inserted at which point the front counter will only display the number of images stored in the expansion card.

WARNING: The above camera will not accept any High Speed memory cards. Common verbiage that will indicate High Speed includes but is not limited to: Extreme, Ultra, Optima, Micro, Platinum, Store and Shoot.

Inserting SD memory card

NOTE: Make sure camera is in the OFF position whenever adding or removing memory.

- Insert SD memory card in to the SD card slot completely and in the correct direction, as shown by the picture shown on the Open View image above (see page 5).
- To remove the SD memory card, depress the SD card and pull out the card gently.
- SD cards must be clean (no images from other sources). If you are using the SD card from other cameras, please make sure to format the SD card in your computer prior to use in the camera. New cards are good to use straight from the package.
- If installed SD card is locked, camera will show LOC on the display, please slide the lock switch to unlock location then reinstall the SD card.

FORMAT – Definition: When you format a SD memory card, the operating system erases all information and files on the card. Then it creates an internal address tables that it later uses to locate information and files. Formatting also removes all Hidden System files as well. Basically it cleans your SD memory card just like if it was brand new. Please make sure to follow the guidelines listed below:

SD Card size: 2GB or below, format using File System type “FAT”.

SD Card size: 4GB or above, format using File System type “FAT32”.

**DO NOT use File System type “NTFS” or “exFAT”, these formats are not supported.*

www.wildviewcam.com

Toll Free 888-304-6125

SETUP AND PROGRAMMING

When the camera is first turned on, the internal LCD screen displays the camera status. The following information is present on this screen.

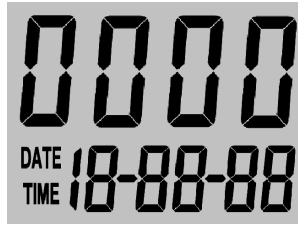

Definitions

- **Cam:** To set which mode you want the camera to be in.
 - TEST = Test mode
 - OFF = Power Off mode
 - ON = Active Passive Infrared mode / Power On mode

- **Time out:** To set the amount of time the camera will sleep between PIR triggering.
 - 20s = 20 Seconds
 - 1m = 1 minute
 - 5m = 5 minutes
 - 10m = 10 minutes

- **Resolution:** The resolution selection that you have chosen.
 - High (HI) = 5.0 Megapixels
 - Low (LO) = 1.3 Megapixels

- **Video:** Sets the length of time how long you want to capture video.
 - 15s = 15 seconds
 - 30s = 30 seconds
 - 60s = 60 seconds
- **Burst:** To set the number of pictures or video length the camera will take per PIR triggering.
 - 1P = Single still image captured per PIR triggering.
 - 3P = Three continuous still images captured per PIR triggering.
 - 6P = Six continuous still images captured per PIR triggering.
 - VIDEO = Places camera in Video mode and will capture video per setting above.
- **Day and Time:** Displays the date and time that you've set, on all still images. For Video, it will appear on the first frame. (Using Quick Time Player or Window Media Player).
- **Moon phase:** Displays the moon phase. For Video, it will appear on the first frame. (Using Quick Time Player or Window Media Player).
- **FULL:** When the external memory capacity reaches full, the front LCD screen will show "FULL."

Programming your Wildview Camera

NOTE: The following setting must be performed before you turn on the camera.

1. Select the time out interval by sliding the **TIME OUT** toggle switch to the desired preset time interval in minutes.
2. Select the resolution setting by sliding the **RESOLUTION** toggle switch to the desired resolution setting.
3. Select the capture mode by sliding the **BURST** toggle switch to the desired amount of pictures or video you want to capture per triggering.
4. Turn on the Camera by sliding the **CAM** toggle switch to the **ON** position.
5. Setting the Date / Time stamp:
 - a. Press and hold **[SET]** button for 2 seconds to enter Date / Time setting mode.
 - b. The word TIME and HH will blink. Press **[UP]** or **[DN]** button to adjust the hour.
 - c. Press **[SET]** button to enter minute setting.
 - d. The word TIME and MM will blink. Press **[UP]** or **[DN]** button to adjust the minute.
 - e. Press **[SET]** button to enter the month setting.
 - f. The word DATE and MM will blink. Press **[UP]** or **[DN]** button to adjust the month.
 - g. Press **[SET]** button to enter date setting.

- h. The word DATE and DD will blink. Press **[UP]** or **[DN]** button to adjust the date.
- i. Press **[SET]** button to enter year setting.
- j. The word DATE and YY will blink. Press **[UP]** or **[DN]** button to adjust the year.
- k. Press and hold **[SET]** button for 2 seconds to exit the setting mode and enter into PIR count down mode.
- l. The TEST light will blink and display will show date and number of pictures taken.
- m. Once the program setting has been completed, slide the **CAM** toggle switch to **OFF** position until you are ready for field use.

NOTE: *Date & Time setting will be lost whenever the batteries are removed from camera. Remember to re-set the Date & Time stamp after you replace the batteries.*

USING THE CAMERA

Once all program settings have been setup properly, your Wildview camera is ready for field use.

Getting started

Listed below are some helpful pointers on how to use your camera to get the best results.

- Mount the camera about 4-5 feet high with the camera pointed at a slight downward angle.
- Mount the camera facing north or south **NOT** east or west due to the rising and setting of the sun could produce false triggers and overexposed images.
- If you're covering a trail, face the camera down or up the trail. Most game scouting cameras take 1-3 seconds to sense motion/heat and take a picture.
- Clear out any brush or weeds in front of camera. This will cause false pictures caused wind or high temperature days.
- Double check batteries before turning on the camera for use.
- Make sure to insert the memory card after setting up the game camera.
- Make sure to turn the camera to the ON position (or take out of Test Mode) before you leave.
- Verify time and date is correct.

Mounting the camera with the supplied strap:

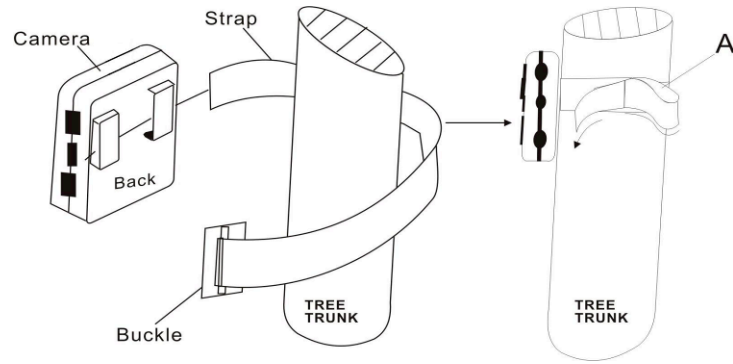

1. Insert the strap through the strap slots on the rear housing.
2. Wrap the strap around the mounting surface. Secure the strap and tighten the buckle in order to secure the camera.

NOTE: In order to obtain proper weather resistance, please make sure that both door latches are securely locked in place.

(Example: Mounting)

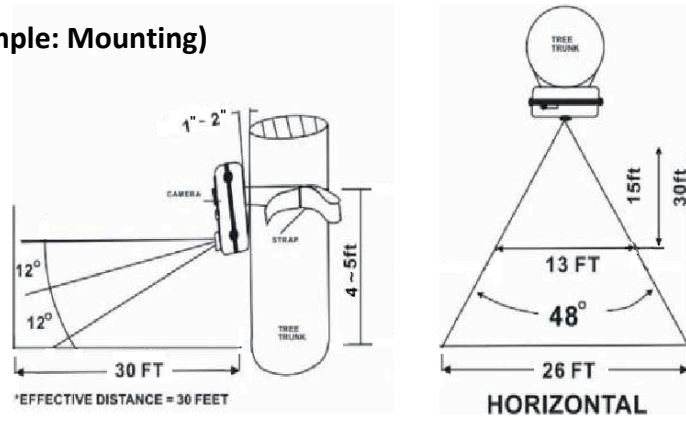

(Example: Trail Setup)

Incorrect

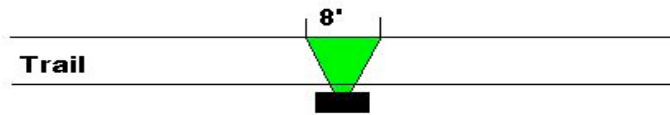

Correct

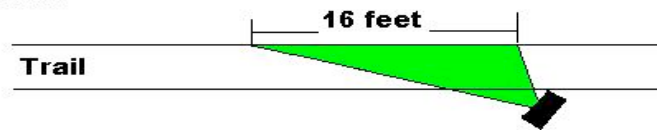

Testing the camera coverage area:

One of Wildview Scouting Camera's features is the ability to test the coverage area.

1. After mounting the camera, open front housing and slide the **CAM** toggle switch to **TEST** position. The front LCD will display the word "tEst".
2. Close the front housing.
3. Walk around to the front of the camera to see if you have mounted the camera in the proper position. The green TEST light indicator on the front will blink when you have intruded the coverage area.
4. Adjust the camera position as needed and repeat testing until the desired coverage area is achieved.
5. When you have completed testing the coverage area, open the front housing and slide the **CAM** toggle switch from **TEST** position to the **ON** position.
 - **Caution:** Do not move the switch from TEST directly to ON. Doing so will cause the camera not to operate. Slide the switch to OFF. Wait for the front LCD screen to turn off, then continue to slide the switch to ON.
6. The front LCD counter will show "0000" and the green indicator light will start blinking. The camera will enter count down mode for 1 minute, giving you one minute to leave the coverage area. Then camera will be armed and enter the PIR detection mode.

NOTE: Make sure you slide the power switch from TEST mode to ON mode before you leave the field, otherwise the Camera will not take any pictures.

VIEWING AND DELETING FILES

Your Wildview Scouting Camera is a plug and play USB storage device for users of Windows 2000 / ME / XP / Vista / Windows 7 operating systems. This camera is not MAC compatible.

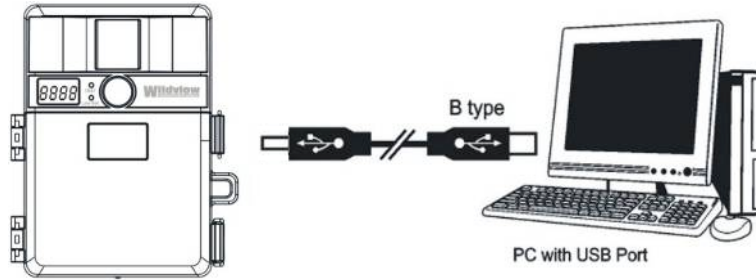

Viewing files from your computer download:

1. FIRST, slide the **CAM** toggle switch to the **OFF** position.
2. Plug the larger end of the USB cable into an available USB port on your computer and plug the smaller end of USB cable into the camera.
3. The camera will automatically power itself on. Front LCD screen will show "USb."
4. At the same time, your computer will recognize the camera as a Removable Storage device, and you can find it under MY COMPUTER.

5. At this point you have several options:
- **To view your images or play your videos:** Click on the Removable Storage device and then drill down to the file you want to see and double click on the file name.
 - **To save your images and videos:** Highlight the file or files you want to save and drag them to your hard drive.
 - **To delete your images and videos:** Highlight the files or files you want to delete and press the **[DELETE]** button.
 - **To erase all files and reformat you SD memory card:** Right click on the Removable Storage device under My Computer and select **FORMAT** then click **START**. You will receive a Warning message press **[OK]**. Then **CLOSE** to exit.

NOTE: Make sure before you FORMAT you are certain it is the Removable Storage device for the camera.

6. Once you're done, simply unplug the cable from both your computer and the camera. The camera will turn OFF automatically.

Deleting files in the field:

Your camera provides you with a few options for deleting files stored on the external memory while in the field.

(Option #1)

1. Slide the **CAM** toggle switch to **ON** position. The LCD screen will display the number of images stored in the memory.
2. Press **[SET]** button to enter Delete mode. Display will show "ESC".
3. Press **[UP]** or **[DN]** button to select the desired function.
 - ESC (No Delete) - No images get deleted.
 - d-ONE (Delete One) - Only the last file will get deleted.
 - d-ALL (Delete ALL) - Deletes ALL images on the SD card.
 - Ft (Format) - Deletes all files and reformats the SD card.

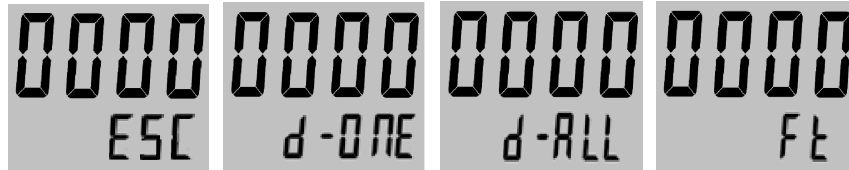

4. Press the **[SET]** button to confirm selection.
5. Press **[UP]** or **[DN]** until screen shows "ESC" then press **[SET]** again to exit.

(Option #2)

Simply remove the batteries from the battery compartment. If you are using an SD memory card as your storage device, you must delete images by following the step described above.

WARNING: Do not remove the batteries until you have downloaded all the images off the internal SDRAM. Once the batteries are removed, all files in the internal SDRAM will be deleted. (This does not apply to files stored on SD memory card).

Low Battery Indicator:

Your camera is equipped with a low battery indicator. The Red Low Bat LED indicator will blink when battery is running low.

1. Turn off the camera.
2. Download all the pictures immediately.

NOTE: DO NOT attempt to replace the batteries before you have saved the images in your PC. Once the batteries are drained completely, or if you attempt to replace the batteries, all images in the internal SDRAM memory will be lost.

3. Replace batteries. Be sure to use brand name alkaline batteries.

MEMORY COMPATIBILITY CHART

The following cards have been tested and approved for use.

Kingmax	2G
SanDisk	2G, 4G, 8G
Toshiba	2G
PNY	2G, 4G, 8G, 16G.
Kingston	2G, 4G, 8G, 16G.
First Champion	1G, 2G, 4G, 8G, 16G.
Lexar	4G, 8G, 16G
DANE-ELEC	4G, 8G, 16G

NOTE: Proper camera operation cannot be guaranteed when using memory cards NOT listed above.

TECHNICAL SPECIFICATIONS

System Requirements and Compatibility

- Windows Me/2000/XP/Vista/ Windows 7
- Pentium 4, 2GHz or above
- 1GB RAM (2GB recommended)
- 32 bits color, resolution 800 x 600 or above. Built in 128MB video memory
- 2GB free hard disc space
- An available USB 1.1 port (USB 2.0 recommended)
- Direct X 9.0 or above – Should come with your operating system already
- Optional: Windows compatible sound card and speaker

NOTE: If you have any questions regarding your PC specifications, please call your PC manufacturer.

CAMERA FEATURES AND SPECIFICATIONS

Model	Mega Pixel	Built in Memory	Resolution Option		
			High	Low	Video
STC-TGL51RNXTS1	5.0M	0MB	5.0M	1.3M	VGA

- Auto white balance and auto expose
- IR Emitter Range – 40ft
- 4 digits LCD Image counter
- Battery low indicator
- Green Test LED indicator
- Focusing: 5 ft to infinity
- High precision multi-layer glass lens with coating
- Effective viewing Angle: 50 degrees
- PIR detection angle: 48 degrees
- Low power consumption:
 - Standby current: < 6mA
 - Capture current: <280mA
- Interface type: USB 1.1
- Power: “C” size alkaline Batteries x 4
- Image format: Images - Standard JPEG / Videos – Standard AVI

IMAGE CAPACITY CHART

SD card	High Color	High B&W	Low Color	Low B&W	Video Color	Video B&W
Based on File Size of	3.5MB	3.0MB	1.0MB	0.75MB	80MB (30sec.)	50MB (30sec.)
Built In 32MB	4	5	20	21	0	0
1GB	228	320	1024	1344	12	20
2GB	456	640	2048	2688	24	40
4GB	912	1280	4096	5376	48	80
8GB	1824	2560	8192	10752	96	160
16GB	3648	5120	16384	21504	192	320

- Subject to card compatibility under different brands.















NOTE: Image Capacity Chart provides approximate number of images or video movies based on resolution settings, and the size of memory card. These figures may vary depending on the amount of detail in the image.

When SD card is NOT FULL, but camera's front counter already reaches 9999, the camera will create a new folder to save the next data. Camera's front counter will reset from 0000 again. On the other hand, when SD card is full, camera's counter will then change the display to "FULL". Image and Video under each folder will be named from 0001 up to 9999.

SD Card Capacity and Compatibility

Due to the rapidly changing memory card market please consult www.wildview.com for the most up to date information regarding memory cards.

MOON PHASE SYMBOL CHART

Symbol	Lunation from	to	Actual phase
	1	5	
	6	10	
	11	14	
	15	16	
	17	20	
	21	25	
	26	29 or 30	

FREQUENTLY ASKED QUESTIONS (FAQs)

Q: *Can I use an external Battery on any Wildview camera?*

A: *With the exception of the TGL1, all our models have an external 12V power jack for connecting to an external Sealed Lead Acid battery.*

Q: *Do I need to recharge my 12V Battery Kit during the seasons I don't use it?*

A: *The 12V Battery Kit should be recharged at least every 3 months, regardless if it is being used or not, in order to preserve the working condition of the battery inside the unit.*

Q: *Can I use rechargeable batteries in the camera?*

A: *Rechargeable batteries are fine for the unit, regular alkaline batteries designed for digital electronics are recommended for best performance.*

Q: *When I use a memory card can I view the pictures on my personal digital camera?*

A: *We do not recommend viewing memory card images taken in your game camera on any other digital camera, you may experience compatibility issues.*

Q: *Does the Wildview camera have a Date/Time stamping built into it?*

A: *With the exception of the TGL1, all our models have the Date/Time stamp function.*

Q: *Can I use my game camera through a window or glass door?*

A: *Glass may disrupt your sensor beam we don't advise using the camera in this fashion.*

Q: *What are my options if my camera is past it warranty?*

A: *We have an out of warranty program in which you may purchase a refurbished/reconditioned replacement unit for 50% or more off (based on retail price of unit) discount exchange of your old unit.*

Q: *What size memory cards can I use with a Wildview camera?*

A: *With technology changing as fast as it does, we suggest checking our website for the most up to date information regarding memory cards.*

Q: *Do any of the Wildview cameras have a 10 second video clip mode?*

A: *Yes, Most of our cameras have a 10 second video clip mode option.*

Q: *What mode does the camera need to be in to download pictures?*

A: *To download a picture, the power must be in the "OFF" position.*

NOTE: *For the latest updates and information please check our website regularly at www.wildviewcam.com*

WARNING: Modification not approved by the party responsible for compliance could void user's authority to operate.

FCC COMPLIANCE

This equipment has been tested and found to comply with the limits for Class B digital device, pursuant to part 15 of the FCC Rules. These limits are designed to provide reasonable protection against harmful interference in a residential installation. This equipment generates uses and can radiate radio frequency energy and, if not installed and used in accordance with the instructions, may cause harmful interference to radio or television receptions, which can be determined by turning the equipment off and on, the user is encouraged to try to correct the interference by one or more of the following measure:

- Reorient or relocate the receiving antenna.
- Increase the separation between the equipment and the receiver.
- Connect the equipment into an outlet on a circuit different from that to which the receiver is connected.
- Consult the dealer or an experienced radio/TV technician for help.

Product specifications are subject to change. Wildview is not responsible for any photographic or typographical errors.

May be protected by one or more U.S. Patent numbers: 6,735,387 / 6,768,868 / 6,834,162 / 7,149,422 / 7,308,196 / 7,593, 632 / 7,710,457

www.wildviewcam.com

Toll Free 888-304-6125